

User's Manual

Models CL-65, CL-30
Amplified DECT Cordless Telephone
With Talking CID & Talking Keypad
(CL-65 = 55 dB; CL-30 = 40 dB)

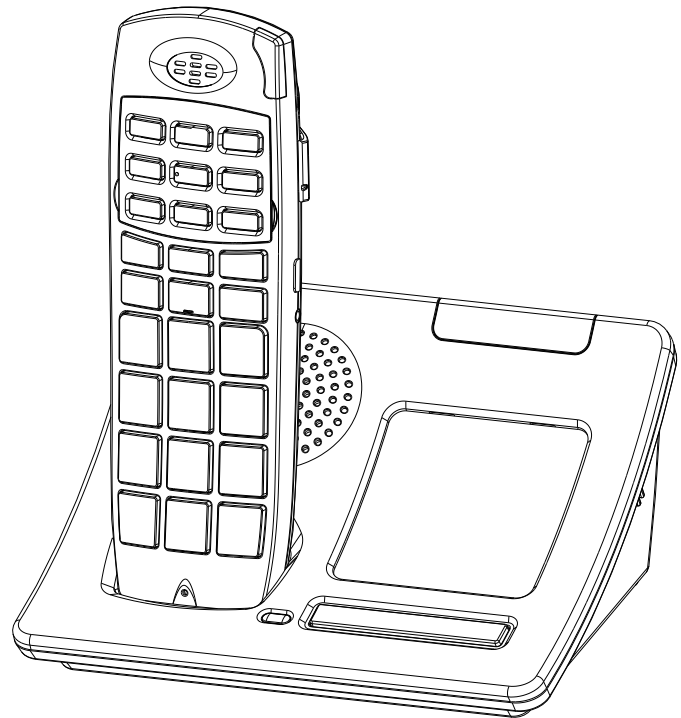

Thank you for purchasing this product, please read before use
(Keep this manual for future reference)

CONTENT

- 1 Product Features----- 1
- 2 Important safety instructions ----- 2-3
- 3 Package content----- 4
- 4 Installation-----4
- 5 Detailed features and controls-----5-6
- 6 Answering a call----- 7
- 7 Making a call----- 7
- 8 Receiver volume control----- 7
- 9 **AMP** (Amplify) function----- 7
- 10 Receiver tone control----- 7-8
- 11 Automatic **AMP** Function, Talking function &
Language Switches ----- 8
- 12 Programming one-touch memories----- 8
- 13 Dialing from a one-touch memory----- 9
- 14 Change handset ringer tone and volume----- 9
- 15 Register a new handset to base----- 9-10
- 16 De-register all handsets----- 10
- 17 Dialing mode setting----- 10
- 18 “Battery low” warning tone----- 10
- 19 out-of-range warning tones----- 11
- 20 Handset and base default setting----- 11
- 21 Call waiting----- 11
- 22 Intercom between handsets----- 12
- 23 Forward an incoming call from handset 1 to handset 2----- 12
- 24 Conference call----- 13
- 25 Pause function----- 13
- 26 Handset power on / off----- 13
- 27 Specifications ----- 14
- 28 Trouble shooting----- 14-15
- 29 Warranty Service Information ----- 16-18
- 30 FCC Registration Information ----- 19-21

PRODUCT FEATURES

1. DECT6.0 Technology ensures crystal clear conversation
2. Up to 55 dB Of amplification for CL-65 (40 dB for CL-30)
3. "AMPLIFY"key that automatically returns to the last receiver volume setting
4. Four (4) digital tone control settings
5. High performance speakerphone
6. Two types of announcing voice (English & French)
7. Loud ringer in handset
8. Bright ring flasher in handset and base
9. Handset flasher also serves as voice-mail and new-call indicator
10. Voice mail reminder tone every 6 minutes
11. Compatible with FSK CID (Type II) and voice mail signals
12. Extra-large keypad buttons
13. Eight one-touch memories
14. Emergency one-touch memory (dials number and turns on speakerphone)
15. Max link up to 5 handsets
16. Volume adjustment (5 levels)
17. Low battery warning tone; Out-of-range alarm tone
18. 10 handset ring tones
19. Intercom function
20. Three-way conference
21. On-line and Off-Line buttons
22. Battery back-up option on Base
23. Inter-changeable battery between handset and base

Important Safety Instructions

Instructions pertaining to a risk of fire, electric shock or injury to persons. Privacy of communications may not be ensured when using a cordless phone.

Caution: To maintain compliance with the FCC's RF exposure guideline, place the base unit 20 cm from nearby persons.

WARNING-When using electric appliances, basic precautions should always be followed, including the following:

1. Read all the instructions before using the appliance.
2. This product uses rechargeable batteries. Do not use any non-rechargeable battery as charging of this type can cause battery leakage.
3. Always disconnect phone cord to wall jack before changing or installing batteries.
4. To reduce the risk of injury, close supervision is necessary when an appliance is used near children.
5. Do not contact moving parts or any exposed metal surface.
6. Only use attachments recommended or sold by the manufacturer.
7. Do not use outdoors. Do not use near water.
8. To disconnect, turn all controls to the off position, then remove plug from outlet.
9. Do not unplug by pulling on cord. To unplug, grasp the plug, not the cord.
10. Unplug from outlet when not in use and before servicing or cleaning.
11. Do not operate any appliance with a damaged cord or plug, or after the appliance malfunctions or is dropped or damaged in any manner. Return appliance to the nearest authorized service facility for examination, repair, or electrical or mechanical adjustment.

12. To reduce the risk of electric shock, this appliance has a polarized plug (one blade is wider than the other). This plug will fit in a polarized outlet only one way. If the plug does not fit fully in the outlet, reverse the plug. If it still does not fit, contact a qualified electrician to install the proper outlet. Do not change the plug in any way.
13. Avoid using any telephone product during an electrical storm. There may be a remote risk of electric shock from lightning.
14. Do not use the telephone to report a gas leak in the vicinity of the leak.
15. Specifications of this product are subjected to change without notice.

Battery and AC Power Adapter

Handset: Requires 2AAA size NiMH rechargeable batteries (included). **Do not** use any non-rechargeable battery as charging of this type can cause battery leakage. *Fully charged handset batteries can provide 100 hours of standby or 9 hours of talk time (80 hours and 6.5 hours respectively for CL-30).*

Base: Can accept four (4) user provided AAA size NiMH rechargeable batteries for AC power outage backup purpose. Therefore, installation of base batteries is optional. **Do not** use any non-rechargeable battery as charging of this type can cause battery leakage. *Fully charged base batteries can provide ~4 hours of AC power outage backup.*

Please care for the environment by disposing any used batteries through your local community recycle center. Do not dispose any used battery in trash bin.

Swapping Handset Batteries with Base Batteries

Handset and base batteries are inter-changeable. In the event that handset batteries are running low, it is acceptable to swap handset batteries with two from the base. This eliminates handset battery recharge time.

WARNING: For safety consideration, always disconnect phone cord to wall jack before swapping batteries

Disposal of Used Batteries and Safety Information

1. Do not dispse of the battery in a fire as it may explode. Please dispose any used battery through your local community recycle center.
2. Do not open or mutilate the battery. Released electrolyte is highly corrosive and may cause damage to the eyes and skin. It may be toxic if swallowed.
3. Exercise care in handling batteries in order not to short the battery with conducting material such as rings, bracelets and keys. Shorting a battery may overheat and cause burns.

AC Power Adapter

For your safety, please plug the provided AC power adapter into the nearest AC outlet. Use only UL listed Class 2 power adapter, 7.5VDC, 300 MA.

Package Content

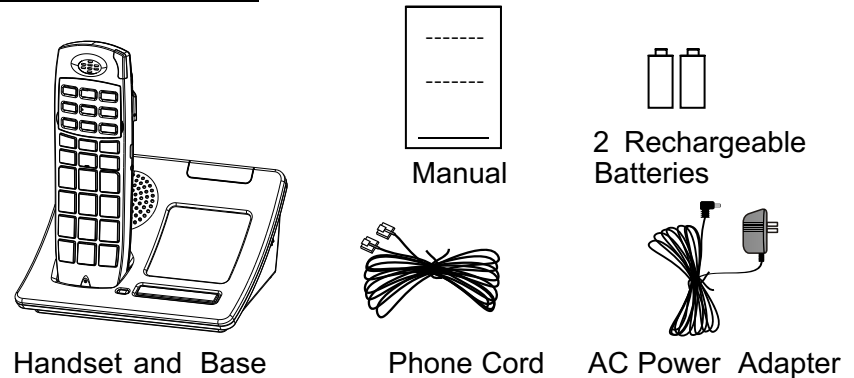

Installation

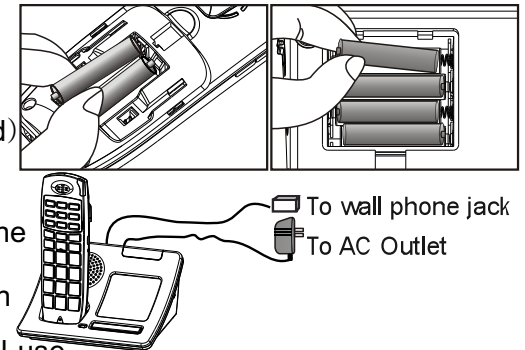

1. Install rechargeable batteries in handset (included) and base (batteries not included) as shown.
2. Connect AC adapter and phone cord to the base as shown.
3. Charge the handset in the base 10 hours or overnight before initial use.



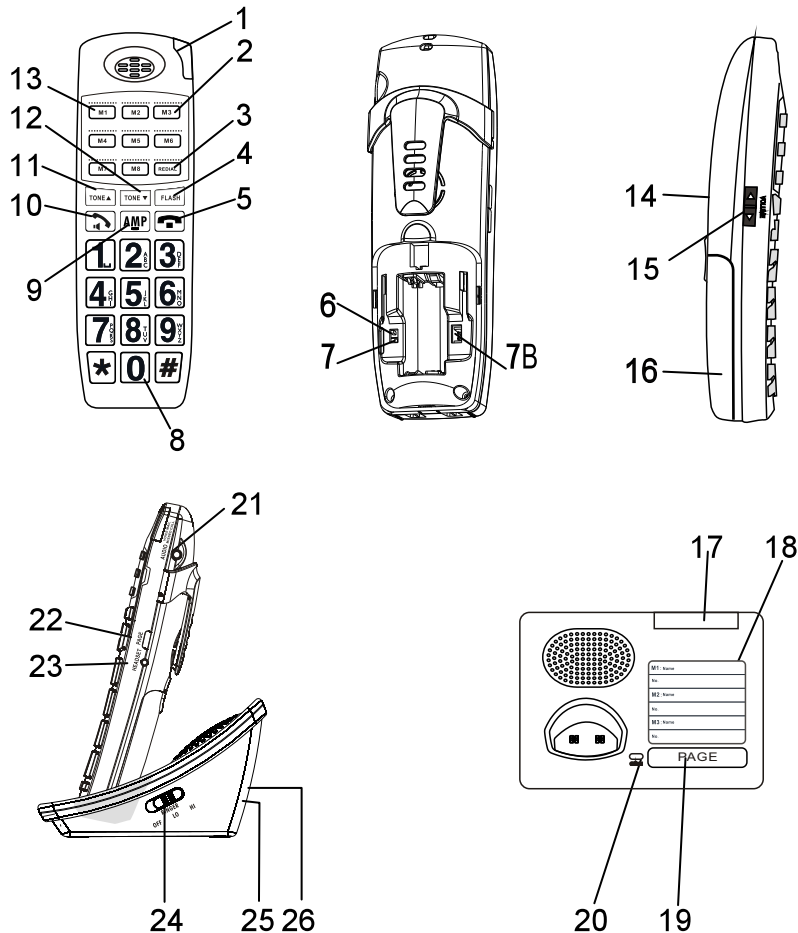

Detailed Features and Controls





1. **In-Use / Ring Flasher / Voice mail / Missed Call** indicator: It flashes slowly if there is a missed call or voice mail (service provided by local phone company); it also beeps every 6 minutes if there is voice mail waiting.
2. **M2 to M8** buttons: One - touch memories
3. **REDIAL** button: Redial / Pause
4. **FLASH** button: Generates a "Flash" signal to activate call waiting (service provided by local phone company).

5.  button: Press to end a call.
6. **Auto-Amplifier** Switch: Enables automatic **AMP** function. (6, 7 & 7B are located in battery compartment).
7. **Talking CID/ Keypad** Switch: Enables Talking CID and Talk-Back feature
- 7B. **Language** Switch: Select either English or French voice output.
8. **Keypad**: Standard phone keypad
9. **AMP** (Amplify) button with indicator: Press to engage extra handset receiver amplification.
10.  button: Press to make or answer a call. During a call, press to engage speakerphone.
11. **TONE ▲** button: For tone control and ringer tone setting.
12. **TONE ▼** button: For tone control and ringer volume setting.
13. **M1** button: One-touch memory that activates speakerphone.
14. **Speaker**: Handset ringer & speakerphone
15.  **VOLUME** Up/Down (side): For receiver & speakerphone volume.
16. **Battery Compartment Cover**
17. **Base Flasher / In-Use** Indicator
18. **One-Touch Memory Directory** Label
19. **Page** Button: Press to page all registered handsets
20. **Charge** Indicator: Indicates handset is charging.
21. **Audio** Jack: For receiver audio output.
22. **Page** button: Press to intercom or transfer a call.
23. **Headset** Jack: For cordless phone headset.
24. **Base Ringer Volume Control**: Hi -Lo -Off
25. **AC Adapter** Jack (rear): For connection to power
26. **Phone** jack (rear): For connection to phone line.



Answering a call

1. Press  key when phone rings.
(Press  again to engage speakerphone if need).
2. Press  key to end the call.

Making a Call

1. Enter phone number on keypad.
2. Press  key to go on-line and dial.
(Press  gain to engage speakerphone if need).
3. Press  key to end the call.



Volume Control (receiver and speakerphone)

1. While on a call, press  key on the handset (side) to change volume setting. A short audio beep is provided on each key activation. A long beep indicates either maximum or minimum volume setting has reached. You should stop pressing in that direction.
2. Press  key to end the call.

AMP (Amplify) Function

1. While on a call, press **AMP** key to add an extra level of amplification (37 dB for CL-65 and 22 dB for CL-30) to the receiver volume. This is indicated by an illuminated button.
2. Press  key to end the call.

Receiver Tone Control

1. While on a call and **AMP** is active (illuminated), digital tone control becomes active.
2. Press  or  key to select one of four tone settings (T1, T2, T3, T4) for best voice clarity. (T1 is the lowest tone setting while T4 is the highest).

Pressing  repeatedly means changing from T1 toward T4. A long beep indicates the highest tone setting has reached (T4). You should stop pressing.

Pressing  repeatedly means changing from T4 toward T1. A long beep indicates the lowest tone setting has reached (T1). You should stop pressing.

3. If necessary, re-adjust receiver volume in order to further enhance voice clarity.
4. Press  key to end the call.

Automatic **AMP** Function, Talking CID/Keypad, Language Switches

The **AMP** function can be set to ON automatically each time the phone is used. This automatic setting can be selected via a slide switch and is recommended for a single user household. Talking CID and Talking Keypad feature can also be set to ON / OFF via a second slide switch.

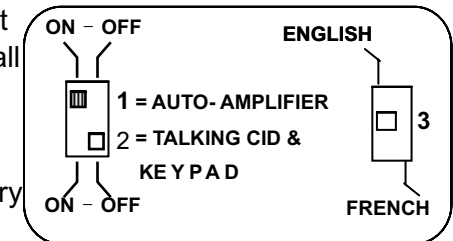

1. Open battery compartment cover to expose three small slide switches as shown.
2. Set Switch 1 to ON if you want **AMP** to be ON every time.
3. Set Switch 2 to ON for talking CID and Talking keypad.
4. Slide Switch 3 for either English or French voice for the talking features.



Programming One-Touch Memories

1. While off-line, enter phone number and confirm.
2. Press and hold  (or M1 to M8) for 5 seconds to save. Verify by a confirmation tone.



Dialing from a One-Touch Memory

1. While off-line, press any one-touch memory key to hear audio confirmation (assume talking feature is on).
2. Press  to go on-line and dial.
3. Press  to end the call.



Change Handset Ringer Tone and Volume

Note: Base ringer tone is fixed. Base ringer volume is controlled by a slide switch located on the side of the base.

Ringer tone or melody setting

1. While off-line, press  key plays the current ringer melody.
2. Press the  key on the side of handset to change the ringer melody (ten melodies total).
3. Press and hold  key for 5 second to save the latest melody for the ringer.

Ringer volume setting

1. While off-line, press  key plays the current ringer melody.
2. Press the  key on the side of handset to change the ringer loudness (five loudness level total).
3. Press and hold  for 5 second to save the latest loudness setting for the ringer.

Register a New Handset to the Base



Note: Handset and base are pre-registered with each other in the factory. They are ready to use out of the box. You only need to do this step if you bought an extra handset for the system. A maximum of five handsets is allowed

1. Press  key on the base for about 5 seconds while off-line, the Ring-Flasher light starts flashing after a loud beep. This indicates the base is ready for handset registration. (Please complete the following steps in less than 120 seconds).

2. While off-line, press and hold the  key on the side of the handset for about 5 seconds. It beeps once and starts searching for the base.
3. Wait about 5 to 30 seconds for registration to take place. Along "du di du" sound indicates a successful registration.

De-Register All Handsets

This step is necessary only if there are too many handsets registered to the base and there is difficulty in registering a new handset.

1. Press  key of base for 5 seconds and the base ringer flasher indicator starts flashing.
2. Press the  key of base seven more times at a normal pace; the ringer flasher indicator should flash at a faster speed than before indicating de-register process is in progress.
3. De-register is complete when the indicator light goes out.
4. All previously registered handsets are now de-registered.
5. You must register the handsets you want again.

Dialing Mode Setting

Both CL-65 and 30 are factory preset for tone dialing

1. While off-line, press and hold  key for 3~5 seconds toggles the dialing mode from tone and pulse (or vice-versa).
2. The dialing mode is announced in voice if the Talking feature is on.
Confirm the correct dialing mode by calling a phone number.

Battery Low Warning Tone

While talking, there will be a periodic short beep sound if the battery is running low. Please recharge handset as soon as possible.

Out-Of-Range Warning Tone

While talking, there will be a long beep sound if the handset is out-of-range from the base. Please walk back toward the base immediately to remedy the situation.

Handset and Base Default Setting (Restore Factory Defaults)

Note: This setting restores factory default settings (tone dialing, ringer volume is set at maximum). All custom settings will be lost. One-touch memories are not affected.



1. While off-line, press and hold  key for 3~5 seconds resets to factory defaults. A beep tone confirms the reset.
2. Please wait 5 ~ 30 seconds for the handset to re-establish handshaking with the base before using. You should hear a long beep tone as confirmation.

Call Waiting



If you are on a call and there is a new call coming in, you will hear a short beep tone in your receiver indicating a new call is waiting.

(Note: You must subscribe to Call Waiting service from your local phone company in order to enjoy this convenience.)

Answer a new call and place the first call on "HOLD"

1. Press  key to answer this new call will automatically place the first call on HOLD.
2. Press  key again to switch back to the first caller while placing the second (new) caller on HOLD. This way you can go back and forth between these two calls.



To end the first call but keep the second (new) call

1. Tell the other party to hang up while on the first call.
2. Press  key jumps back to the second (new) call.
3. Press  key to end the call.





Intercom Between Handsets

1. This function is available when two or more handsets are registered to the same base. The handset that came with each system is HANDSET 1 (HS 1). Each subsequent handset added to the system is automatically assigned as HS 2, HS 3, HS 4 and HS 5. Users need to remember the number of each handset in order to use the intercom function properly.
2. Base must be powered up in order for the intercom function to work.

Intercom from Handset 1 to Handset 2

1. While in the standby mode, press  key on "Handset 1" to initiate intercom tone.
2. Press "2" on "Handset 1" keypad to call. "Handset 2" will ring.
3. The user on "Handset 2" activates  key to enter intercom mode and talk.
4. Press  key on either handset to end the intercom call and returns to the standby mode.





Forward an Incoming Call from Handset 1 to Handset 2

1. On Handset 1, press  key and then press "2" on the keypad. This pages Handset 2 (via intercom) while putting the outside call on HOLD.
2. When Handset 2 rings, press  key on to answer the page.
3. Over the intercom, tell Handset 2 that an outside call is waiting.
4. Press  key on Handset 1 to transfer the call and then press  key on Handset 1 to exit.

(Note: If within 30 seconds there is no answer, the call will ring handset 1.)

Conference Call

This allows two handsets conferencing with the incoming caller.



1. On Handset 1, press  key to answer the incoming call.
2. On Handset 1, press  page key and then press "2" on the keypad to page Handset 2. (This also places the caller on HOLD.)
3. On Handset 2, press  key to answer the page.
4. On Handset 1, press  key to initiate conferencing.
Both Handset 1 and Handset 2 are now connected to the outside caller.
5. On either handset, press  key to end the call and return to off-line.

Pause Function

During pre-dialing or one-touch memory programming, press  key inserts a 2-second pause into the dialing sequence. For example: 9 P 7 2 2 8 8 5 0 where "P" represents a 2-second pause. This pause is needed to access an outside line on some business phone system.

Handset Power On / Off

Power down a handset ignores all calls and saves battery power.

1. Press and hold  key for five seconds, the handset will be off. There will be no Talking keypad and no keypad back-light.
2. Press and hold  key for five more seconds, the handset powers up again.
3. Please wait 5-30 seconds for a "di-du" sound which confirms that handset has established handshaking with the base. The handset is now ready.

Specification

Amplified dB level (Amplify off): 0 to 18 dB in 5 steps

CL-65 Amplified dB level (Amplify on):

37 to 55 dB (measured at 3 KHz with Tone=4)

CL-30 Amplified dB level (Amplify on):

22 to 40 dB (measured at 3 KHz with Tone=4)

Tone control settings: 4 settings (T1 = lowest tone, T4 = highest tone)

Talking CID / Keypad voice: English or French

Flash time: 600 msec

Dialing: Tone or pulse

Specifications are adjusted to change without any notice

Dimensions

Handset size: 7.0"x 2.1"x 1.2"

Base size: 6.7"x 3.1"x 5.0"

Weight

Handset weight: 5.7 oz.

Base weight: 16 oz.

Temperature range:

Operating: 0 to 40°C

Storage: -10 to 50°C

Power requirements:

AC Adapter: UL listed 7.5vdc, 300 ma

Base battery: 4 xAAA size NIMH (optional and are provided by user)

Handset battery: 2 xAAA size NIMH (included)

Trouble Shooting

Q1: Base Charging Indicator is not on when handset is placed on the base.

Ans: Move the handset slightly to make better contact.

Q2: No CID announcement on an incoming call.

Ans: Make sure the Talking CID feature is turned on (check Switch 2 setting in battery compartment). Check your CID subscription with your phone company.

Q3: No Dial tone.

Ans: Check AC adapter and phone cord connection. Make sure the handset is not powered off. If this is a brand new handset, you must register it to the base before using.

Q4: No keypad backlight on handset.

Ans: Verify battery is OK; make sure the handset is not powered off. (Press and hold the  key for 5 seconds to power up the handset).

Q5: Handset flasher works but handset does not ring.

Ans: Verify handset ringer volume is not set at minimum.

Q6: Why is the handset flasher always blinking?

Ans: This indicates you have voice mail waiting in your provider's voice mail server or, you have missed a call. Press and hold  for 5 seconds clears this indicator.

Q7: Why does the handset beeps every few minutes?

Ans: In addition to the voice mail indicator, CL-65 and CL-30 provide an audio indicator to alert the user on the presence of voice mail. It beeps once every 6 minutes (du-du-du du-di-du). Or, if the handset battery is running low, you will hear a short beep tone (du) once in a while. Or, if you are using the handset too far from the base, you will also hear a warning beep tone indicating out-of-range situation.

Q8: Static noise on the line.

Ans: Your phone may be located near a touch lamp, microwave, or other appliance. If you have a DSL computer modem service, make sure you have installed a DSL filter to block the DSL noise.

Warranty Service Information

Your CL Cordless Phone comes with one-year limited warranty. We warrant during this warranty period, from the date of purchase, to the original consumer, the CL Cordless Phone to be free from defects in materials and workmanship under intended home use. In the event that CL Cordless Phone fails to function properly within one year of original purchase due to defects in materials or workmanship, return the unit (freight prepaid) with proof of purchase (sales receipt or packing slip, no exceptions) to Serene Innovations. Serene Innovations will either repair or replace the unit (with a refurbished unit or unit of equal condition) and return it to you (using UPS/USPS ground shipping) at no cost to you if the unit is returned within 30 days of purchase. If the unit is returned after 30 days of purchase but within the warranty period, there will be a warranty handling charge of \$9.95 for each return.

Incidental or Consequential Damages: Neither Serene Innovations, Inc. nor retailer, dealer or selling distributor has any responsibility for any incidental or consequential damages including without limitation, commercial loss of profit, or for any incidental expense, loss of time, or inconvenience. Some states do not allow exclusion or limitation of incidental or consequential damage, so the above limitation or exclusion may not apply to you.

This warranty does not apply to any product that has been accidentally damaged, abused, misused or negligent, used on electrical frequency or voltage other than marked on product and/or described in manual. Defects or errors caused by unauthorized alterations, repairs, and/or tampering are also not covered by this warranty.

This Warranty gives you specific legal rights, and you may also have other legal rights that vary from states to states.

If a defect covered by this warranty should occur, promptly contact a Customer Care Representative by phone or log onto

www.sereneinnovations.com to obtain a Return Authorization Number (RAN) and shipping instructions before shipping the product to us. Any shipment without a RAN will not be accepted and will be returned to you at your expense. Any authorized returned product must be accompanied with proof of purchase and a brief explanation of the problem.

For out of warranty repaired and service, please contact our Customer Care Department for directions.

This equipment complies with Part 68 of the FCC Rules.

On the equipment is a label that contains, among other information, the FCC registration number and ringer equivalence number (REN) for this equipment. If requested; this information must be provided to your telephone company.

This equipment uses the following Universal Service Order Codes ("USOC") jacks: RJ-11. Connection to the telephone network should be made by using standard modular telephone jack type RJ11.

The REN is useful to determine the quantity of devices you may connect to your telephone line and still have all of those devices ring when your telephone number is called. In most, but not all areas, the sum of the RENs of all devices connected to one line should not exceed five (5.0). To be certain of the number of devices you may connect to your line, as determined by the REN, you should contact your local telephone company to determine the maximum REN for your calling area.

If your telephone equipment causes harm to the telephone network, the telephone company may discontinue your service temporarily. If possible, they will notify you in advance. But if advance notice is not practical, you will be notified as soon as possible. You will be informed of your right to file a complaint with the FCC.

Your telephone company may make changes in its facilities, equipment, operations or procedures that could affect the proper functioning of your equipment. If they do, you will be notified in advance to give you an opportunity to maintain uninterrupted telephone service.

In the event this equipment should fail to operate properly, disconnect the unit from the telephone line. Try using another FCC approved telephone in the same telephone jack. If the trouble persists, call the telephone company repair service bureau.

If the trouble does not persist and appears to be with this unit, disconnect the unit from the telephone line and discontinue use of the unit until it is repaired. For repair or warranty information, please contact Serene Innovations, Inc. at 562-407 5400. Please note that the telephone company may ask that you disconnect this equipment from the telephone network until the problem has been corrected or until you're sure that the equipment is not malfunctioning.

There are no user serviceable parts in this equipment.

This equipment may not be used on coin service provided by the telephone company. Connection to party lines is subject to state tariffs. Contact the state public utility commission, public service commission for information.

If your home has specialty wired alarm equipment connected to the telephone line, ensure the installation of this equipment does not disable your alarm equipment. If you have questions about what will disable alarm equipment, consult your telephone company or a qualified installer.

Part 15 of FCC Rules Information

This device complies with Part 15 of the FCC rules. Operation is subject to the following two conditions: (1) This device may not cause harmful interference, and (2) this device must accept any interference received, including interference that may be caused by undesired operations.

This equipment has been tested and found to comply with the limits of a Class B digital device, pursuant to Part 15 of FCC rules. These limits are designed to provide reasonable protection against harmful interference in residential installations.

This equipment generates, uses and can radiate radio frequency energy and, if not installed and used in accordance with the instructions, may cause harmful interference to radio communications. However, there is no guarantee that interference will not occur in a particular installation. If this equipment does cause harmful interference to radio or television reception, which can be determined by turning the equipment off and on, you may try one of the following suggestions to correct the interference:

1. Where it can be done safely, re-orient the receiving television or radio antenna.
2. To the extent possible, relocate the television, radio, or other receiver with respect to the cordless phone.
3. Connect the cordless phone AC adapter into a different electrical outlet.
4. Consult the dealer or an experienced radio/TV technician for help.

Modification: Any modification not expressly approved by the manufacturer of this device could void the user's authority to operate the device.

NOTICE: The Industry Canada label identifies certified equipment.

This certification means that the equipment meets telecommunications network protective, operational and safety requirements as prescribed in the appropriate Terminal Equipment Technical Requirements document(s). The Department does not guarantee the equipment will operate to the user's satisfaction.

Before installing this equipment, users should ensure that it is permissible to be connected to the facilities of the local telecommunications company. The equipment must also be installed using an acceptable method of connection. The customer should be aware that compliance with the above conditions may not prevent degradation of service in some situations.

Repairs to certified equipment should be coordinated by a representative designated by the supplier. Any repairs or alterations made by the user to this equipment, or equipment malfunctions, may give the telecommunications company cause to request the user to disconnect the equipment. Users should ensure for their own protection that the electrical ground connections of the power utility, telephone lines and internal metallic water pipe system, if present, are connected together. This precaution may be particularly important in rural areas.

Caution: Users should not attempt to make such connections themselves, but should contact the appropriate electrician.

inspections authority, or electrician, as appropriate. The REN for this amplified telephone as stated on the IC regulatory label located on the bottom of the product.

NOTICE: The Ringer Equivalence Number (REN) assigned to each terminal device provides an indication of the maximum number of terminals allowed to be connected to a telephone interface. The termination on an interface may consist of any combination of devices subject only to the requirement that the sum of the Ringer Equivalence Numbers of all the devices does not exceed 5.

This Class B digital device complies with Canadian ICES-003.